

ø30 ARN/ARNS Series Mono-lever Switches

Single lever offers up to four directions of control

- Mono-lever switches operate in four directions using a single lever. Switch contacts are actuated in the direction in which the lever is pushed, enabling quick and accurate control in any desired direction. Ideal for machine tools and industrial machines. The lever action can be maintained or spring-returned in any combination.
- Also available with interlock mechanism to prevent inadvertent actuation.



- See website for details on approvals and standards.



Contact Ratings by Utilization Category

Rated Insulation Voltage			600V					
Rated Continuous Current			10A					
Operational Voltage			24V	48V	50V	110V	220V	440V
Operational Current	AC 50/60 Hz	AC-12 Control of resistive loads and solid state loads	10A	—	10A	10A	6A	2A
		AC-15 Control of electromagnetic loads (> 72 VA)	10A	—	7A	5A	3A	1A
	DC	DC-12 Control of resistive loads and solid state loads	10A	5A	—	2.2A	1.1A	—
		DC-13 Control of electromagnets	4A	2A	—	1.1A	0.6A	—

Note: The operational current represents the classification by making and breaking currents (IEC 60947-5-1).

Specifications

Contact Configuration	Double-break slow action Each contact block contains two independent contacts (2NO, 1NO-1NC, 2NC) Up to four contact blocks can be mounted
Operating Temperature	-25 to +50°C (no freezing)
Storage Temperature	-35 to +80°C (no freezing)
Operating Humidity	45 to 85% RH (no condensation)
Insulation Resistance	100 MΩ minimum (500V DC megger)
Dielectric Strength	Between live and dead parts: 2,500V AC, 1 minute
Mechanical Life	500,000 operations minimum
Electrical Life	(Interlocking: 250,000 operations minimum)
Lever Knob	Black
Weight (approx.)	276g (ARN4-1111-20202020)

BR Contact Block

The contact block is made of nylon resin. Each contact block contains two pairs of double-break silver contacts. There are three types as shown in the diagram below and up to four contact blocks can be mounted in any direction.

A wide variety of circuits allows diverse combinations of control.

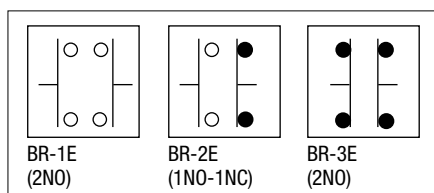

Control Mechanism

When the operator lever is pushed to about 30° in each direction from the neutral position, the contact in that direction activates. The lever can operate in two, three, or four directions, and combinations of maintained or spring-return from any position are possible.

APEM

Switches & Pilot Lights

Control Boxes

Emergency Stop Switches

Enabling Switches

Safety Products

Explosion Proof

Terminal Blocks

Relays & Sockets

Circuit Protectors

Power Supplies

LED Illumination

Controllers

Operator Interfaces

Sensors

AUTO-ID

Flush Silhouette

ø16

ø22

ø30

Miniature

Pilot Lights

TWN



TWN D

ARN

CS

ø30 ARN/ARNS Series Mono-lever Switches

Mono-lever Switches

	Operator	Number of Contact Blocks	Part No. (Ordering Part No.)	Package Quantity
ARN (Long Lever)		1 Block	ARN1-③-④B	1
		2 Block	ARN2-③-④B	
		3 Block	ARN3-③-④B	
		4 Block	ARN4-③-④B	
ARNS (Short Lever)		1 Block	ARNS1-③-④B	
		2 Block	ARNS2-③-④B	
		3 Block	ARNS3-③-④B	
		4 Block	ARNS4-③-④B	
ARNL (Interlocking)		1 Block	ARNL1-③-④B	
		2 Block	ARNL2-③-④B	
		3 Block	ARNL3-③-④B	
		4 Block	ARNL4-③-④B	

The operator lever is locked only in the center position.

Specify Contact Configuration from the table below in place of ③ and ④.
Terminal covers are ordered separately.

Dimensions

ARN (Long Lever)

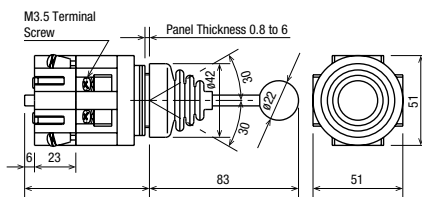

1 block: 47, 2 blocks: 70
3 blocks: 93, 4 blocks: 116

Minimum horizontal/vertical mounting centers: 110

ARNS (Short Lever)

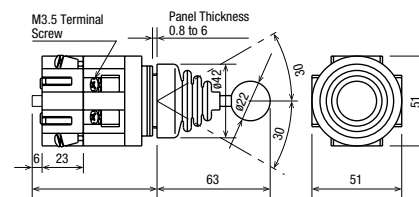

1 block: 47, 2 blocks: 70
3 blocks: 93, 4 blocks: 116

Minimum horizontal/vertical mounting centers: 70

ARNL (Interlocking)

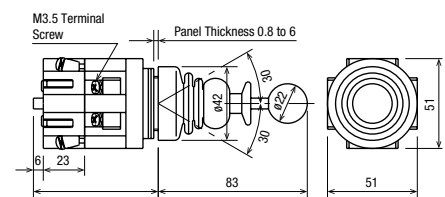

1 block: 47, 2 blocks: 70
3 blocks: 93, 4 blocks: 116

Minimum horizontal/vertical mounting centers: 110

Lever Operator Position

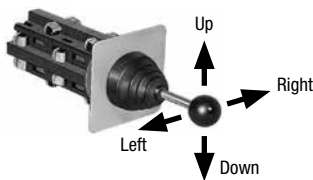

Panel Cut-Out

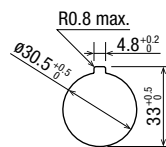

Mono-Lever with Terminal Cover

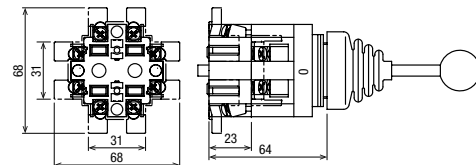

Ordering Information

When ordering, specify items ① to ⑤ according to the following example.

[Example] ① ARN ② 4 - ③ 1012 - ④ 20 00 02 11 ⑤ B

① Model	② No. of Contact Blocks	③ Lever Action	④ Contact Arrangement	⑤ Lever Knob Color
ARN ARNS ARNL	1: 1 block 2: 2 blocks 3: 3 blocks 4: 4 blocks	Order of Entry: Up→Right→ Down→Left 1: Maintained 2: Spring return 0: Blocked	Order of Entry: Up→Right→ Down→Left 10: 1NO 01: 1NC 11: 1NO-1NC 20: 2NO 02: 2NC 00: Blocked	B: black

Contact Block Position	Terminal No.	Direction of Lever Operation				Terminal No.	Contact Block Type
		Lever Operation Mode					
		1	0	1	2		
1	1	NO	—	—	—	2	BR-2E
	3	—	—	NC	—	4	
2	5	—	NO *	—	—	6	BR-1E
	7	—	—	—	NO	8	
3	9	NO	—	—	—	10	BR-2E
	11	—	—	NC	—	12	
4	13	—	NC *	—	—	14	BR-3E
	15	—	—	—	NC	16	

*: Contacts marked with * do not operate.





- To calculate the number of contact blocks required, add the number of NO and NC contacts on each pair of adjoining positions (up + right, right + down, down + left, and left + up). The largest of the four sums is the number of contact blocks required. Up to four contact blocks can be mounted.

- Specify the same number of contacts for the contact blocks of opposing corner (up-down, right-left), except for the blocked direction.

- When UL and CSA markings are required on the mono-lever switch, specify as shown below.

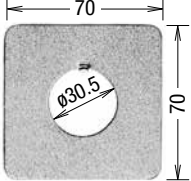
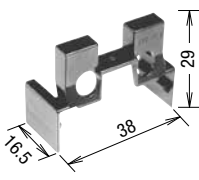
[Example] ARN4-1012-20000211B-U

Accessories and Maintenance Parts

Shape	Specification	Part No.	Ordering No.	Package Quantity	Description
Nameplate		MLO	MLO	1	Chrome-plated brass (matte surface)
			MLOPN10	10	
Terminal Cover		ARN-VL2	ARN-VL2	1	Terminal covers are ordered separately. When ordering, specify the Part No. and the required quantity. Order 2 pieces for each contact block.
Contact Block (BR)		BR-1E	BR-1E	1	2NO contact
		BR-2E	BR-2E	1	1NO-1NC contact
		BR-3E	BR-3E	1	2NC contact
Bellows		ARN-BL	ARN-BL	1	For ARN/ARNS (Locking ring not included)
		ARN-BL-1	ARN-BL-1		For ARN/ARNS (Locking ring included)
Bellows (Interlocking)		ARNL-BL	ARNL-BL	1	For ARNL (Locking ring not included)
Knob		ARNB-③	ARNB-③	1	Specify a color code in place of ①. B (black), G (green), R (red) For ARN/ARNS

APEM

Switches & Pilot Lights

Control Boxes

Emergency Stop Switches

Enabling Switches

Safety Products

Explosion Proof

Terminal Blocks

Relays & Sockets

Circuit Protectors

Power Supplies

LED Illumination

Controllers

Operator Interfaces

Sensors

AUTO-ID

Flush Silhouette

ø16

ø22

ø30

Miniature

Pilot Lights

TWN

TWND

ARN

CS

ø30/ø25 CS Series Cam Switches

71 standard circuits to choose from

- Wide variety of heavy-duty oiltight cam switches
- Operators available up to 12 positions
- Contact blocks rated at 600V, 10A
- Ideal for ammeter/voltmeter applications
- UL listed and CSA approved



- See website for details on approvals and standards.



Specifications and Ratings

Contact Ratings by Utilization Category

Rated Insulation Voltage		600V				
Rated Continuous Current		10A				
Operational Voltage		24V	110V	220V	440V	
Operational Current	AC 50/60 Hz	AC-12 Control of resistive loads and solid state loads	—	10A	6A	2A
		AC-15 Control of electromagnetic loads (> 72 VA)	—	5A	3A	1A
	DC	DC-12 Control of resistive loads and solid state loads	8A	3A	1A	0.4A
		DC-13 Control of electromagnets	5A	1.2A	0.45A	0.2A

Note: The operational current represents the classification by making and breaking currents (IEC 60947-5-1).

Specifications

Contact Configuration	Double-break slow action contacts Two contacts in one deck Up to 6 decks available (Spring-return: Up to 3 decks)	
Operation	Maintained	Spring return
Angle	30°, 45°, 60°, 90°	45°
Operator Positions	2 to 12 2, 3, 4	
Operating Temperature	-20 to +50°C (no freezing)	
Storage Temperature	-40 to +80°C (no freezing)	
Operating Humidity	45 to +85% RH (no condensation)	
Insulation Resistance	100 MΩ (500V DC megger)	
Dielectric Strength	2500V AC, 1 minute (between live and dead parts)	
Mechanical Life	1 to 3 decks: 500,000 operations 4 to 6 decks: 200,000 operations	
Electrical Life	200,000 operations minimum	
Degree of Protection	ACSNO, ACSO: IP65 (IEC 60529) ACS NK, ACS SK: IP54 (IEC 60529) UCS: IP40 (IEC 60529)	
Weight (approx.)	319g (ACSNO-663-S2B)	





CSB Contact Block

The CSB contact block contains two poles of double-break contacts. The contacts are operated by a cam designed to perform a required contact operation. Up to six contact blocks can be mounted on a maintained-action operator base, and up to three contact blocks on a spring return operator base.

M3.5 Screw Terminal

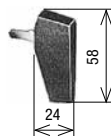

Cam Switches

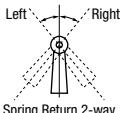
① Model		② Contact Block Decks	③ Positions	④ Angle	⑤ Spring Return	⑥ Handle	⑦ Contact Arrangement	Nameplate
ø30 Series	ø25 Series							
ACSNO	ACSSO	Maintained: 1 to 6 decks Spring return: 1 to 3 decks	Maintained: 2 to 12 positions Spring return: 2 to 4 positions	Maintained: 30°, 45°, 60°, 90° Spring return: 45° only	Spring return from right Spring return from left Spring return two-way	Y2, S2, P2, 25S2 (25S2 is for ACSSO only) (one specified handle supplied) (Note 1)		See B-361 (ordered separately)
 (Photo: ACSNO with Y2 handle)								
ACS NK	ACSSK	Maintained: 1 to 6 decks Spring return: 1 to 3 decks	Maintained: 2 to 8 positions Spring return: 2 to 4 positions	Maintained: 45°, 90° Spring return: 45° only	Spring return from right Spring return from left Spring return two-way	Two standard keys are supplied. When the H2 key handle is required, specify H2.		See B-362 to B-364.
 Standard Key (2 keys supplied)								
 H2 Handle Key (black)								
UCSQO	(Enclosed)	Maintained: 1 to 6 decks Spring return: 1 to 3 decks	Maintained: 2 to 12 positions Spring return: 2 to 4 positions	Maintained: 30°, 45°, 60°, 90° Spring return: 45° only	Spring return from right Spring return from left Spring return two-way	Y2, S2, P2 (one specified handle supplied)		Type CQ See B-361 (ordered separately)
 (Photo: With Y2 handle)								
UCSQM	(Enclosed)	Spring return: 1 to 3 decks	Spring return: 3 positions	Spring return: 45° only	Spring return two-way		C1007 C1008 C1009 C1010 C1018 C2006 C2007 C2021 See B-362 to B-364.	Type CQM See B-361 (ordered separately)
 Indicator Left: Green Right: Red								
 Left Right Spring Return 2-way								

Note 1: The applicable handle for ACSSO is 25S2 only. The applicable handle for ACSNO is Y2, S2, and P2 only.

Dimensions

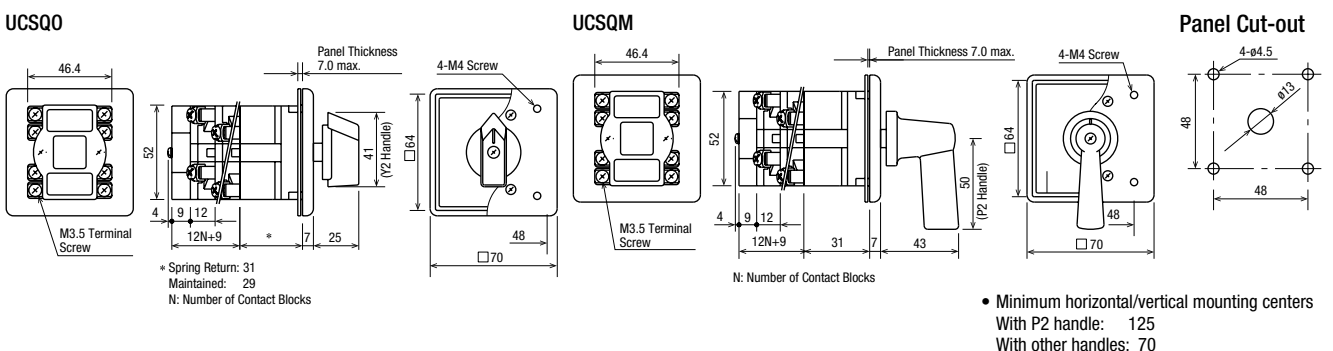
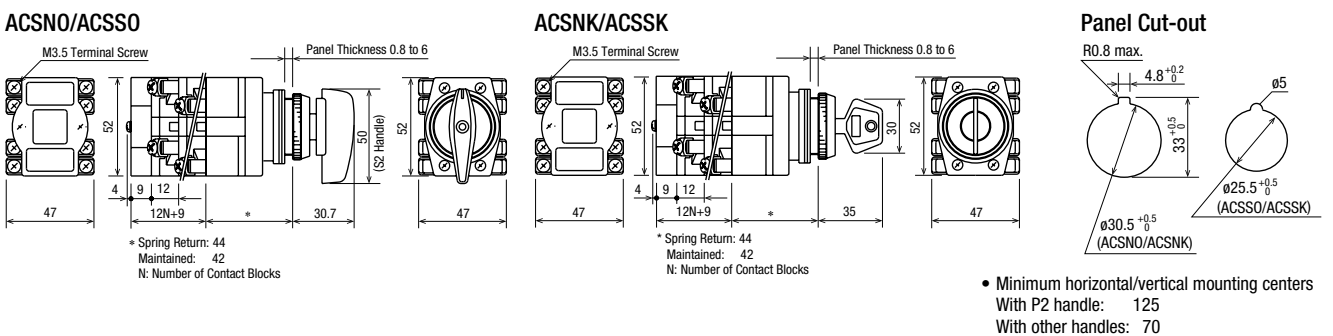

ø30/ø25 CS Series Cam Switches

Ordering Information

When ordering, specify items ① through ⑦ as the designation example below.

①	②		③		④		⑤		⑥	⑦	⑧	
Model	Contact Block Decks		Positions		Angle		Spring Return		Handle	Key irremovable position	Circuit No.	
①	Decks	Code	Positions	Code	Angle	Code	Return	Code	⑥	⑦	⑧	
APEM	ACSNO	1 deck	1	2 positions	2	30°	3	Spring return	RO	(Code) Y2, S2, P2, H2, 25S2 (Color) B: Black See table below.	For ACSNK/ ACSSK, specify the code(s) of irremovable position(s) in numerical order.	For standard contact configurations, use designation code on B-362 to B-364 . For custom contact configurations, use the Custom Contact Configuration Specification Sheet on B-365 .
Switches & Pilot Lights	ACSNO	2 decks	2	3 positions	3	45°	4	from left	OR			
Control Boxes	ACSSO	3 decks	3	4 positions	4	60°	6	Spring return				
Emergency Stop Switches	ACSSK	4 decks	4	5 positions	5	90°	9	from right	RR			
Enabling Switches	UCSQO	5 decks	5	6 positions	6			Spring return				
Safety Products	UCSQM	6 decks	6	7 positions	7			two-way				
Explosion Proof				8 positions	8							
Terminal Blocks				9 positions	9							
Relays & Sockets				10 positions	10							
Circuit Protectors				11 positions	11							
Power Supplies				12 positions	12							
LED Illumination												
Controllers												
Operator Interfaces												
Sensors												
AUTO-ID												
Flush Silhouette												
ø16												
ø22												
ø30												
Miniature												
Pilot Lights												
TWN												
TWND												
ARN												
CS												

Designation Example

UCSQO - 2 3 4 RR - S2B - C2006

① ② ③ ④ ⑤ ⑥ ⑧

ACSNO - 2 3 4 RR - Y2B - MAU-C2006-ZT2

① ② ③ ④ ⑤ ⑥ ⑧

- When a special contact configuration is required, specify the contact configuration using the Custom Contact Configuration Specification Sheet on **B-365**.
- A specified handle is attached.
- Accessories such as nameplates and jumpers are separately ordered.
- The key of the key operated cam switch is removable at every position unless otherwise specified. The key is irremovable at return position. The return and irremovable positions must be specified in Part No. Positions at 180° from irremovable positions are also irremovable.
Example: 4-positions, spring return from right, irremovable at positions 3 and 4

ACSNO-3440R-134-C3012

Handle Designation Code

Shape	Code	Color	Applicable Cam Switch
	Y2	B: black	ACSNO UCSQO UCSQM
	S2		
	25S2		
	P2		ACSNO UCSQO UCSQM
	H2		ACSNO ACSSK



Spring Return Operation



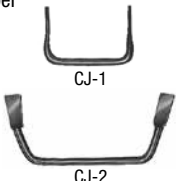

Available combinations of operator positions, angles, and return directions are listed in the table below.

Positions	2-position		3-position			4-position		3-position
	From Left	From Right	From Left	From Right	Two-way	From Left	From Right	Two-way
Return Direction								
③ ④ ⑤ Codes	24RO	24OR	34RO	34OR	34RR	44RO	44OR	34RR
Applicable Cam Switches	ACSNO, ACSSO, ACSNK, ACSSK, UCSQO							UCSQM
Contact Block Decks	1 to 3 decks							

Note: Maintained do not require spring return code ⑤.

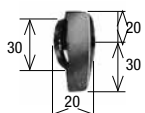
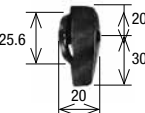
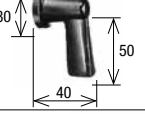
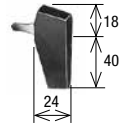
Accessories and Maintenance Parts

Shape	Material	Part No.	Ordering No.	Package Quantity	Remarks
Jumper  CJ-1 CJ-2	Metal (copper)	CJ-1	CJ-1PN10	10	For connecting terminals of adjoining contact blocks
		CJ-2	CJ-2PN10	10	For connecting terminals of the same contact block
Rubber Boot 	Nitril rubber	CR-1	CR-1	1	For preventing ingress of dust into the contact blocks Not applicable for the UCSQO and UCSQM
Terminal Cover  CS-VL2-13S CS-VL2-46S Supplied with 2 self-tapping screws for mounting	Plastic (PPE)	CS-VL2-13S	CS-VL2-13S	1	For 1 to 3 decks of contact blocks
		CS-VL2-46S	CS-VL2-46S	1	For 4 to 6 decks of contact blocks

Shape	Material (Color)	Part No.	Ordering No.	Package Quantity
ø30 Y Handle 	Polybutylene terephthalate (Black)	CSH-YB	CSH-YB	1
ø30 S Handle 	Polybutylene terephthalate (Black)	CSH-SB	CSH-SB	1
ø25 S Handle 	Phenol resin (Black)	CSH-25SB	CSH-25SB	1
ø30 P Handle 	Phenol resin (Black)	CSH-PB	CSH-PB	1
Key Handle 	Phenol resin (Black)	CSH-H2B	CSH-H2B	1
Spare Keys 	Metal (brass nickel-plated)	CSH-K301	CSH-K301PN02	2
Handle Shaft 	Polyamide	CS-HF2C	CS-HF2CPN05	5
Handle Screw 	For Y, ø30 S, and ø25 S handles M3 × 12	CS-SCW-M3-12	CS-SCW-M3-12PN10	10
Handle Screw 	For P and F handles M3 × 25	CS-SCW-M3-25	CS-SCW-M3-25PN10	10

- APEM
- Switches & Pilot Lights
- Control Boxes
- Emergency Stop Switches
- Enabling Switches
- Safety Products
- Explosion Proof
- Terminal Blocks
- Relays & Sockets
- Circuit Protectors
- Power Supplies
- LED Illumination
- Controllers
- Operator Interfaces
- Sensors
- AUTO-ID
- Flush Silhouette
- ø16
- ø22
- ø30
- Miniature
- Pilot Lights
- TWN
- TWND
- ARN
- CS

Instructions

Installing the Terminal Cover for the CS series Cam Switches

- Complete wiring before installing the terminal cover on the bottom plate of the contact block.
- The terminal cover has six holes. Of the four round holes at four corners, use two diagonal pair of holes to install the terminal cover. Either pair can be used.
- Insert the attached self-tapping screws into the pair of holes and tighten the screws to a torque of 0.8 to 1.0 N·m.
- For 1 through 3 decks of contact blocks, use terminal cover CS-VL2-13S.
- For 4 through 6 decks of contact blocks, use terminal cover CS-VL2-46S.
- The CS-VL2-46S consists of the CS-VL2-13S and a terminal cover for the fourth through sixth decks. Combine the two parts together as shown. Note that once combined, the two parts cannot be separated.

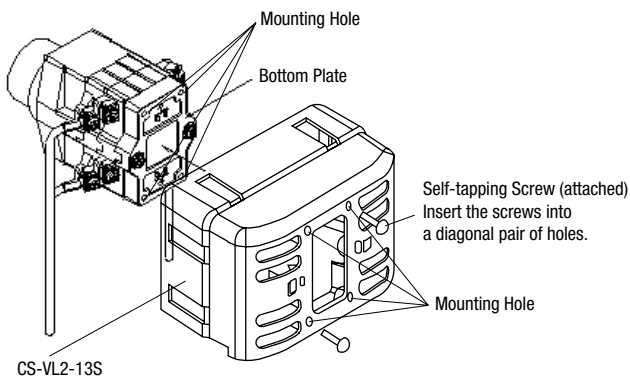

Minimum Mounting Centers for Installing the Terminal Cover

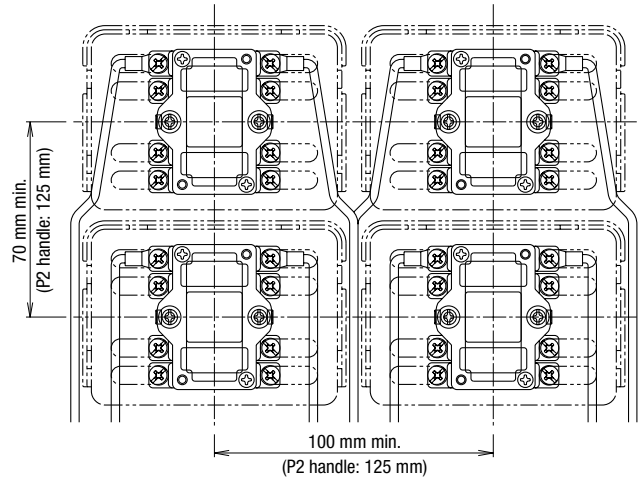

- Although the minimum mounting centers are 100 mm horizontally and 70 mm vertically, determine the mounting centers in consideration of convenience of wiring. For the P2 handle, the minimum mounting centers are 125 mm horizontally and vertically.

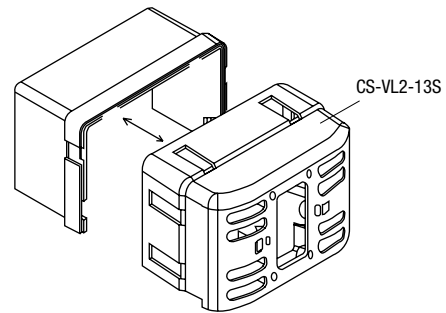

For 4 through 6 decks of contact blocks (CS-VL2-46S)

Terminal Cover Dimensions

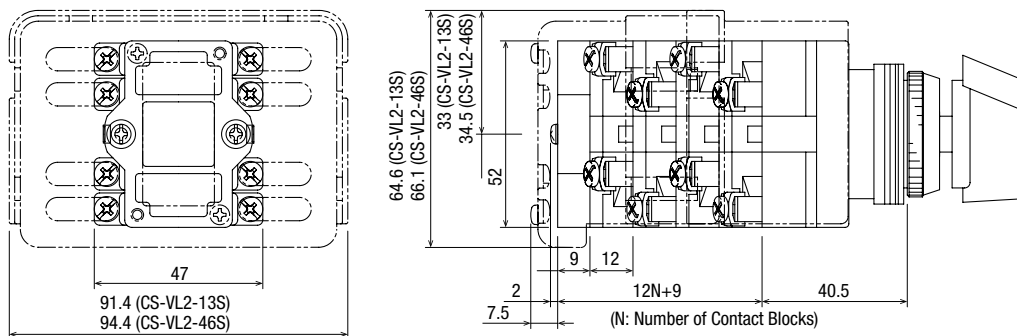

All dimensions in mm.

APEM

Switches & Pilot Lights

Control Boxes

Emergency Stop Switches

Enabling Switches

Safety Products

Explosion Proof

Terminal Blocks

Relays & Sockets

Circuit Protectors

Power Supplies

LED Illumination

Controllers

Operator Interfaces

Sensors

AUTO-ID

Flush Silhouette

ø16

ø22

ø30

Miniature

Pilot Lights

TWN

TWN

ARN

CS

Accessories and Maintenance Parts

For $\phi 25$ / $\phi 30$ Cam Switches

Shape	Panel-cut Size	Material	Part No.	Ordering No.	Package Quantity	Remarks
Tool Locking Ring Wrench 	$\phi 25$ $\phi 30$	Nitril rubber (black)	OR-12	OR-12	1	<ul style="list-style-type: none"> Used to tighten the locking ring when installing the $\phi 30$ or $\phi 25$ switch onto a panel. 
	Anti-rotation Ring 	$\phi 25$	Metal (diecast) (zinc-plated)	OGL-21	OGL-21PN10	10
$\phi 30$		OGL-11		OGL-11PN10	<ul style="list-style-type: none"> Used to prevent the operator from turning. Generally used when using no nameplates on selector switches and selector pushbuttons. 1 piece included with cam switches 	
Mounting Plug 	$\phi 25$	Nitril rubber (black)	OBS-13B	OBS-13BPN05	5	<ul style="list-style-type: none"> Used to plug unused $\phi 25.5$mm mounting holes. Protection degree: IP65 (round hole) IP40 (anti-rotation) 
		Nitril rubber (gray)	OBS-13	OBS-13PN05		
	$\phi 30$	Nitril rubber (black)	OB-13B	OB-13BPN05		<ul style="list-style-type: none"> Used to plug unused $\phi 30$mm mounting holes. Protection degree: IP40 
		Nitril rubber (gray)	OB-13	OB-13PN05		
Plastic 	$\phi 30$	Plug: ABS, gray Gasket: Chloroprene rubber	OBP-11	OBP-11	1	<ul style="list-style-type: none"> Tightening torque: 1.2 N·m. Degree of protection: IP65 (when hole for anti-rotation is not available) Locking ring provided 
Metal 	$\phi 30$	Plug: Zinc diecast chrome-plated Gasket: Chloroprene rubber Locking ring: Zinc diecast	OB-11	OB-11	1	<ul style="list-style-type: none"> Tightening torque: 1.2 N·m. Degree of protection: IP65 (when hole for anti-rotation is not available) Locking ring provided 
Bezel 	$\phi 25$	Metal (Zinc diecast chrome-plated)	OG-22	OG-22PN02	2	<ul style="list-style-type: none"> $\phi 30$ ($\phi 21$) H9 Cannot used with monolevers $\phi 35$ H9
	$\phi 30$	Metal (Zinc diecast chrome-plated)	OG-11	OG-11PN02		
Rubber washer 	$\phi 25$	Synthetic soft vinyl	OW-22	OW-22PN10	10	<ul style="list-style-type: none"> $\phi 33.8$ ($\phi 25.5$) H3
			$\phi 30$	OW-12		
	$\phi 25$	Synthetic soft vinyl	OW-21	OW-21PN10	10	<ul style="list-style-type: none"> $\phi 33.8$ ($\phi 25.5$) H1.5
			$\phi 30$	OW-11		

APEM

Switches & Pilot Lights

Control Boxes

Emergency Stop Switches

Enabling Switches

Safety Products

Explosion Proof

Terminal Blocks

Relays & Sockets

Circuit Protectors

Power Supplies

LED Illumination

Controllers

Operator Interfaces

Sensors

AUTO-ID

Flush Silhouette

$\phi 16$

$\phi 22$

$\phi 30$

Miniature

Pilot Lights

TWN

TWND

ARN

CS

ARN/CS

Nameplates

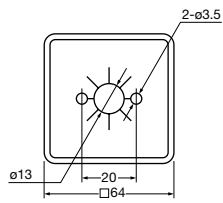
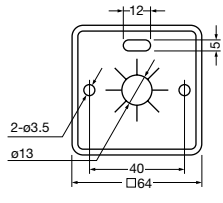
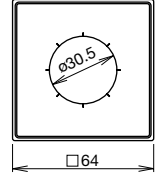
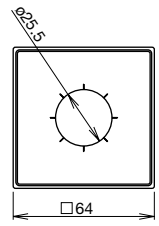
Item	Legend	Material	Part No.	Ordering No.	Package Quantity	Dimensions (mm)	Applicable Unit
CQ	Blank	Aluminium 0.5 mm thick White letters on black background	CQ-0	CQ-0	1	With adhesive tapes on the back 	UCSQO Cam Switch
				CQ-0PN10	10		
	With Legend (Legend Codes 31 and 53 only)		CQ-□	CQ-□	1		
				CQ-□PN10	10		
CQM	Blank	Aluminium 0.5 mm thick White letters on black background	CQM-0	CQM-0	1	With adhesive tapes on the back 	UCSQM Cam Switch
				CQM-0PN10	10		
	With Legend (Legend Code 31 only)		CQM-□	CQM-□	1		
				CQM-□PN10	10		
CQN	Blank	Aluminium 0.5 mm thick White letters on black background	CQN-0	CQN-0	1	With adhesive tapes on the back 	ACSNO, ACSNK Cam Switches ø30 mm Selector Switches
				CQN-0PN10	10		
	With Legend (Legend Codes 31, 35, and 53 only)		CQN-□	CQN-□	1		
				CQN-□PN10	10		
CQS	Blank	Aluminium 0.5 mm thick White letters on black background	CQS-0	CQS-0	1	With adhesive tapes on the back 	ACSSO, ACSSK Cam Switches ø25 mm Selector Switches
				CQS-0PN10	10		
	With Legend (Legend Code 53 only)		CQS-□	CQS-□	1		
				CQS-□PN10	10		

• Specify a legend code in place of □ in the Ordering No.

Legends

Code	Legend
0	(blank)
1	ON
2	OFF
3	START
4	STOP
31	OFF-ON
35	HAND-AUTO
53	HAND-OFF-AUTO



Safety Precautions

- Turn off the power before starting installation, removal, wiring, maintenance, and inspection of the products. Failure to turn power off may cause electrical shocks or fire hazard.
- To avoid a burn on your hand, use the lamp holder tool when replacing lamps.
- For wiring, use wires of a proper size to meet the voltage and current requirements. Tighten the M3.5 terminal screws to a tightening torque of 1.0 to 1.3 N·m. Failure to tighten terminal screws may cause overheat and fire.

Standard Contact Configurations

- The following table lists 76 standard contact configurations for easy designation of required cam switch operation.
- When other contact configurations are required, specify the number of contact block decks, operator positions, angles, and contact operation using the Custom Contact Configuration Specification Sheet on **B-358**.

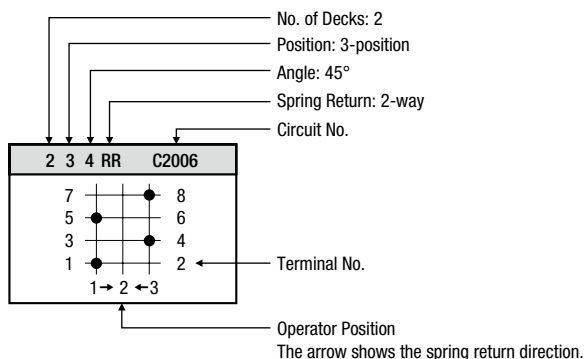

Symbol	Contact Operation
●	Contacts closed.
—	Contacts remain closed between two operator positions.
	Overlapping Contacts Contacts of different decks are both closed at one point while the handle is turned to the next position.
	Residual Contacts When the handle is returned to the center, the contacts remain closed. The contacts are opened when the handle is turned to the opposite direction.

The 76 standard contact configurations are listed in the order of the circuit number.

Same Circuits

Shown in the following examples, circuits of Fig. 1 and Fig. 2 have the same functions. When ordering, examine the standard contact configurations. Your requirements may be satisfied simply by changing external wiring of the standard contact configurations.

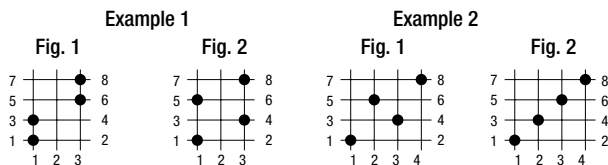

Terminal Numbers

- The terminal numbers on the contact blocks correspond with the numbers shown in the chart as shown below.

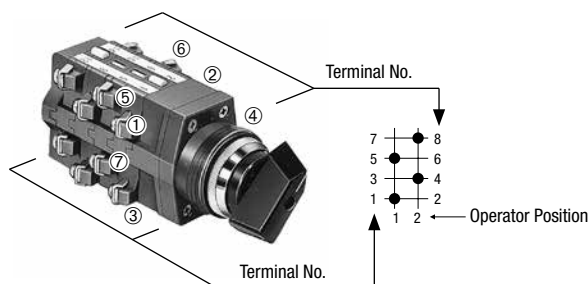

Listing Order of the Table

Standard Contact Configuration Chart									
1 2 9	C1001	1 2 9	C1002	1 2 4 OR	C1003	1 2 4 OR	C1004	1 3 4	C1005

APEM

Switches & Pilot Lights

Control Boxes

Emergency Stop Switches

Enabling Switches

Safety Products

Explosion Proof

Terminal Blocks

Relays & Sockets

Circuit Protectors

Power Supplies

LED Illumination

Controllers

Operator Interfaces

Sensors

AUTO-ID

Flush Silhouette

ø16

ø22

ø30

Miniature

Pilot Lights

TWN

TWWD

ARN

CS

ARN/CS

Cam Switches

2 3 4 RR C2006	2 3 4 RR C2007	2 4 4 C2008	2 4 4 C2009	2 4 9 C2011
2 2 9 C2014	2 2 9 C2015	2 3 4 C2016	2 3 4 C2017	
2 3 4 C2019	2 3 4 C2020	2 3 4 RR C2021	2 4 4 C2022	
		2 5 3 C2027	2 3 6 C2028	2 3 6 C2029
3 2 9 C3001	3 3 4 C3002	3 5 4 C3003	3 6 4 C3004	3 3 4 C3005
3 4 9 C3008	3 4 9 C3009	3 2 9 C3010	3 3 4 C3011	3 4 4 C3012
3 6 3 C3013	3 3 6 C3014	3 6 6 C3015	3 5 3 C3016	3 4 4 C3017
3 3 6 C3018		4 4 4 C4001	4 8 4 C4002	4 4 9 C4003
4 2 4 C4004	4 2 9 C4005	4 2 9 C4006	4 4 9 C4007	4 3 4 C4008

- APEM
- Switches & Pilot Lights
- Control Boxes
- Emergency Stop Switches
- Enabling Switches
- Safety Products
- Explosion Proof
- Terminal Blocks
- Relays & Sockets
- Circuit Protectors
- Power Supplies
- LED Illumination
- Controllers
- Operator Interfaces
- Sensors
- AUTO-ID
- Flush Silhouette
- ø16
- ø22
- ø30
- Miniature
- Pilot Lights
- TWN
- TWND
- ARN
- CS
- ARN/CS

<p>4 5 4 C4009</p>	<p>5 3 4 C5001</p>	<p>6 4 4 C6001</p>	<p>6 12 3 C6002</p>
<p>6 4 9 C6003</p>	<p>6 9 3 C6004</p>	<p>6 6 6 C6005</p>	<p>6 6 4 C6006</p>

Application Examples (Voltmeter and Ammeter Circuits)

<p>1 2 6 C1019 (ammeter switching, 1CT circuit)</p>	<p>2 3 6 C2029 (ammeter switching, 2CT circuit)</p>	<p>2 4 9 C2011 (ammeter switching, 2CT circuit)</p>
<p>2 4 4 C2022 (voltmeter switching, 3PT circuit)</p>	<p>3 4 9 C3008 (voltmeter switching, 2PT circuit)</p>	<p>3 4 9 C3009 (voltmeter switching, 3PT circuit)</p>
<p>6 4 9 C6003 (ammeter switching, 3CT circuit)</p>	<p>4 4 9 C4003 (ammeter switching, 3CT circuit)</p>	<p>4 4 9 C4007 (ammeter switching, 2CT circuit)</p>

- APEM
- Switches & Pilot Lights
- Control Boxes
- Emergency Stop Switches
- Enabling Switches
- Safety Products
- Explosion Proof
- Terminal Blocks
- Relays & Sockets
- Circuit Protectors
- Power Supplies

LED Illumination

Controllers

Operator Interfaces

Sensors

AUTO-ID

Flush Silhouette

ø16

ø22

ø30

Miniature

Pilot Lights

TWN

TWWD

ARN

CS

ARN/CS

Cam Switches

Custom Contact Configurations Specification Sheet

- The preceding pages provide 68 standard contact configurations. When other contact configurations are required, specify the number of contact block decks, operator positions, angles, and contact operation using the Custom Contact Configuration Specification Sheet shown below.
- For available number of contact blocks and operator positions, see the Ordering Information on **B-357**.

1. Specify operator positions

Indicate the operator positions starting at the first position. When spring return operation is required, mark an arrow between two operator positions to indicate the spring return direction.

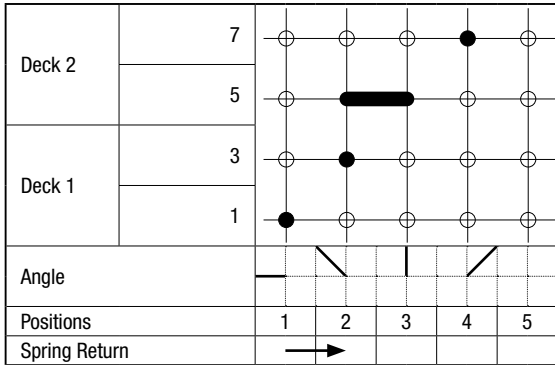

2. Specify contact operation at each operator position

Indicate the required operation of all contacts at each operator position using the following symbols.

Symbol	Contact Operation
●	Contacts closed.
■	Contacts remain closed between two operator positions.
	Overlapping Contacts Contacts of different decks are both closed at one point while the handle is turned to the next position. Overlapping contacts are not available for handle angles of 30° and 45°.
○●	Residual Contacts When the handle is returned to the center, the contacts remain closed. The contacts are opened when the handle is turned to the opposite direction.

- One deck of contact block contains two poles of contacts and four terminals. When the handle is made to turn 180° or more, special attention is needed. Since one cam operates the two poles of contacts on opposite positions, the same contact operation repeats on the other pole of contacts when the handle is turned 180°. When different contact operation is needed for handle angles of 180° or more, use another deck of contact block.

CS Series Cam Switch Custom Contact Configuration Specification Sheet													
Part No.:		<div style="border: 1px dashed black; padding: 5px; display: flex; justify-content: space-around;"> ① Model ② Decks ③ Positions ④ Angle ⑤ Spring Return ⑥ Handle </div>										Quantity: _____	
Deck	Terminal No.	Contact Configuration Chart										Terminal No.	
Deck 6	23	○	○	○	○	○	○	○	○	○	○	○	24
	21	○	○	○	○	○	○	○	○	○	○	○	22
Deck 5	19	○	○	○	○	○	○	○	○	○	○	○	20
	17	○	○	○	○	○	○	○	○	○	○	○	18
Deck 4	15	○	○	○	○	○	○	○	○	○	○	○	16
	13	○	○	○	○	○	○	○	○	○	○	○	14
Deck 3	11	○	○	○	○	○	○	○	○	○	○	○	12
	9	○	○	○	○	○	○	○	○	○	○	○	10
Deck 2	7	○	○	○	○	○	○	○	○	○	○	○	8
	5	○	○	○	○	○	○	○	○	○	○	○	6
Deck 1	3	○	○	○	○	○	○	○	○	○	○	○	4
	1	○	○	○	○	○	○	○	○	○	○	○	2
Angle													
Positions		1	2	3	4	5	6	7	8	9	10	11	12
Spring Return													

Ordering Terms and Conditions

Thank you for using IDEC Products.

By purchasing products listed in our catalogs, datasheets, and the like (hereinafter referred to as "Catalogs") you agree to be bound by these terms and conditions. Please read and agree to the terms and conditions before placing your order.

1. Notes on contents of Catalogs

- (1) Rated values, performance values, and specification values of IDEC products listed in this Catalog are values acquired under respective conditions in independent testing, and do not guarantee values gained in combined conditions.
Also, durability varies depending on the usage environment and usage conditions.
- (2) Reference data and reference values listed in Catalogs are for reference purposes only, and do not guarantee that the product will always operate appropriately in that range.
- (3) The specifications / appearance and accessories of IDEC products listed in Catalogs are subject to change or termination of sales without notice, for improvement or other reasons.
- (4) The content of Catalogs is subject to change without notice.

2. Note on applications

- (1) If using IDEC products in combination with other products, confirm the applicable laws / regulations and standards.
Also, confirm that IDEC products are compatible with your systems, machines, devices, and the like by using under the actual conditions. IDEC shall bear no liability whatsoever regarding the compatibility with IDEC products.
- (2) The usage examples and application examples listed in Catalogs are for reference purposes only. Therefore, when introducing a product, confirm the performance and safety of the instruments, devices, and the like before use. Furthermore, regarding these examples, IDEC does not grant license to use IDEC products to you, and IDEC offers no warranties regarding the ownership of intellectual property rights or non-infringement upon the intellectual property rights of third parties.
- (3) When using IDEC products, be cautious when implementing the following.
 - i. Use of IDEC products with sufficient allowance for rating and performance
 - ii. Safety design, including redundant design and malfunction prevention design that prevents other danger and damage even in the event that an IDEC product fails
 - iii. Wiring and installation that ensures the IDEC product used in your system, machine, device, or the like can perform and function according to its specifications
- (4) Continuing to use an IDEC product even after the performance has deteriorated can result in abnormal heat, smoke, fires, and the like due to insulation deterioration or the like. Perform periodic maintenance for IDEC products and the systems, machines, devices, and the like in which they are used.
- (5) IDEC products are developed and manufactured as general-purpose products for general industrial products. They are not intended for use in the following applications, and in the event that you use an IDEC product for these applications, unless otherwise agreed upon between you and IDEC, IDEC shall provide no guarantees whatsoever regarding IDEC products.
 - i. Use in applications that require a high degree of safety, including nuclear power control equipment, transportation equipment (railroads / airplanes / ships / vehicles / vehicle instruments, etc.), equipment for use in outer space, elevating equipment, medical instruments, safety devices, or any other equipment, instruments, or the like that could endanger life or human health
 - ii. Use in applications that require a high degree of reliability, such as provision systems for gas / waterworks / electricity, etc., systems that operate continuously for 24 hours, and settlement systems
 - iii. Use in applications where the product may be handled or used deviating from the specifications or conditions / environment listed in the Catalogs, such as equipment used outdoors or applications in environments subject to chemical pollution or electromagnetic interference
If you would like to use IDEC products in the above applications, be sure to consult with an IDEC sales representative.

3. Inspections

We ask that you implement inspections for IDEC products you purchase without delay, as well as thoroughly keep in mind management/maintenance regarding handling of the product before and during the inspection.

4. Warranty

- (1) Warranty period
The warranty period for IDEC products shall be one (1) year after purchase or delivery to the specified location. However, this shall not apply in cases where there is a different specification in the Catalogs or there is another agreement in place between you and IDEC.
- (2) Warranty scope
Should a failure occur in an IDEC product during the above warranty period for reasons attributable to IDEC, then IDEC shall replace or repair that product, free of charge, at the purchase location / delivery location of the product, or an IDEC service base. However, failures caused by the following reasons shall be deemed outside the scope of this warranty.
 - i. The product was handled or used deviating from the conditions / environment listed in the Catalogs
 - ii. The failure was caused by reasons other than an IDEC product
 - iii. Modification or repair was performed by a party other than IDEC
 - iv. The failure was caused by a software program of a party other than IDEC
 - v. The product was used outside of its original purpose
 - vi. Replacement of maintenance parts, installation of accessories, or the like was not performed properly in accordance with the user's manual and Catalogs
 - vii. The failure could not have been predicted with the scientific and technical standards at the time when the product was shipped from IDEC
 - viii. The failure was due to other causes not attributable to IDEC (including cases of force majeure such as natural disasters and other disasters)Furthermore, the warranty described here refers to a warranty on the IDEC product as a unit, and damages induced by the failure of an IDEC product are excluded from this warranty.

5. Limitation of liability

The warranty listed in this Agreement is the full and complete warranty for IDEC products, and IDEC shall bear no liability whatsoever regarding special damages, indirect damages, incidental damages, or passive damages that occurred due to an IDEC product.

6. Service scope

The prices of IDEC products do not include the cost of services, such as dispatching technicians. Therefore, separate fees are required in the following cases.

- (1) Instructions for installation / adjustment and accompaniment at test operation (including creating application software and testing operation, etc.)
- (2) Maintenance inspections, adjustments, and repairs
- (3) Technical instructions and technical training
- (4) Product tests or inspections specified by you

The above content assumes transactions and usage within your region. Please consult with an IDEC sales representative regarding transactions and usage outside of your region. Also, IDEC provides no guarantees whatsoever regarding IDEC products sold outside your region.

IDEC CORPORATION

Head Office 6-64, Nishi-Miyahara-2-Chome, Yodogawa-ku, Osaka 532-0004, Japan

 www.idec.com

USA IDEC Corporation
EMEA APEM SAS

Singapore IDEC Izumi Asia Pte. Ltd.
Thailand IDEC Asia (Thailand) Co., Ltd.
India IDEC Controls India Private Ltd.

China IDEC (Shanghai) Corporation
IDEC Izumi (H.K.) Co., Ltd.
Taiwan IDEC Taiwan Corporation

Japan IDEC Corporation

Specifications and other descriptions in this brochure are subject to change without notice.

2022 IDEC Corporation, All Rights Reserved.

